

Bänder/ Hinges

FH 400G

BN AL

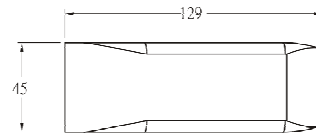
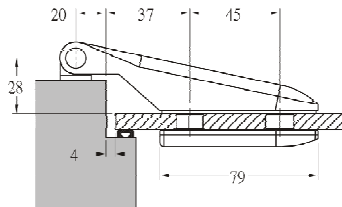

FH 400N

BN AL

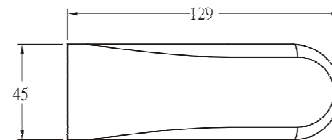
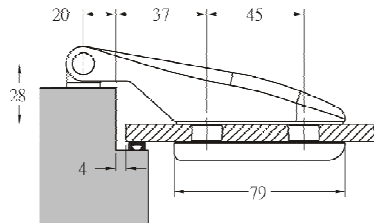

FH 400R

BN AL

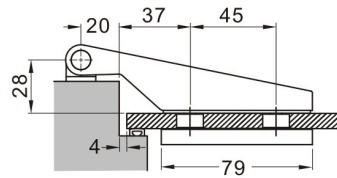

2



FH 410C

BN AL

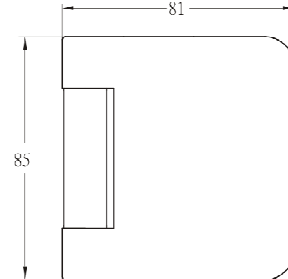
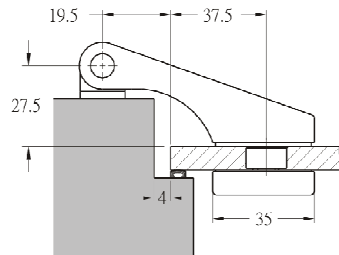

FH 410G

BN AL

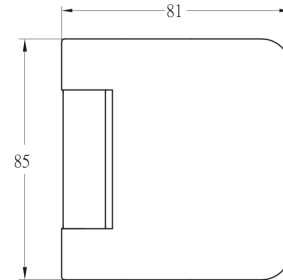
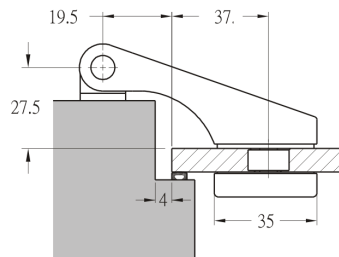

FH 410S

BN AL BL

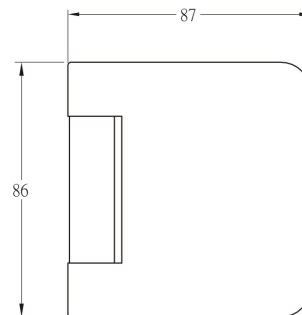
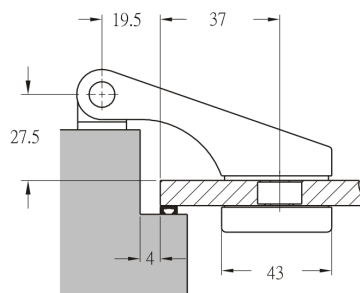

FH 411C

BN AL

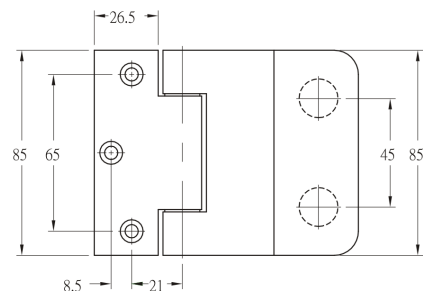
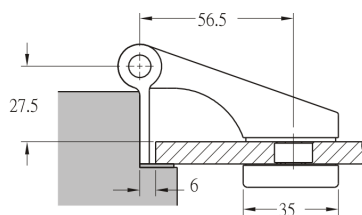

FH 416R

BN PC

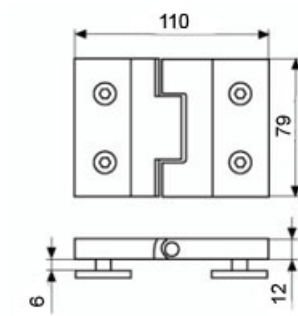

2

FH 061R

BN AL

Zargenunabhängiges
Band

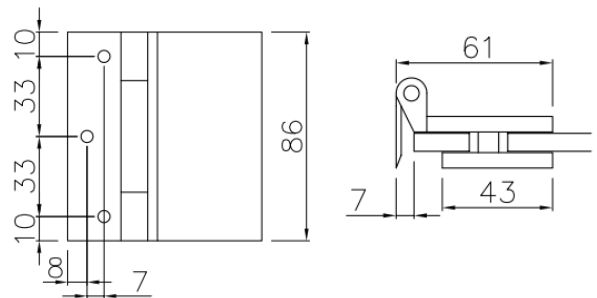

FH 061S

BN AL

Zargenunabhängiges
Band

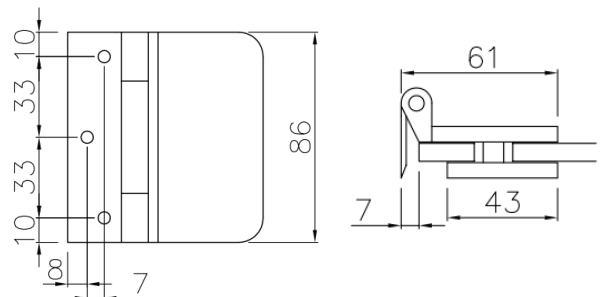

Glass Cut Outs

FH 400G/N/R

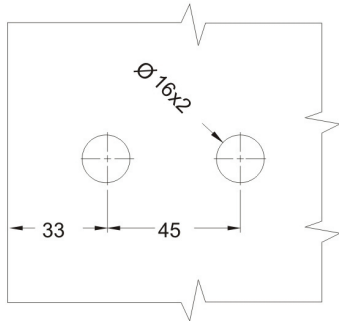

FH 410C/G/S

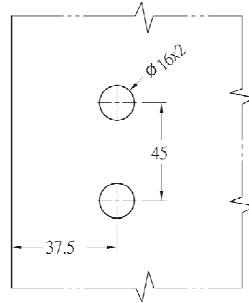

FH 411C

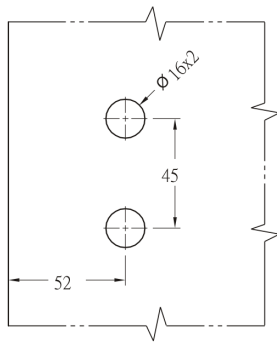

FH 416R

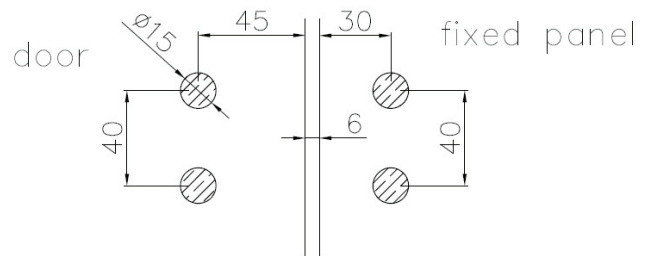

FH 061R/S

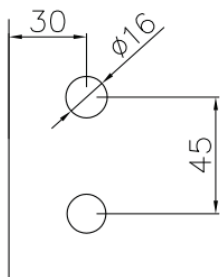

**Bandunterteile für FH 400-Serie/
Fixing system of FH 400-series**

4001

BN BL

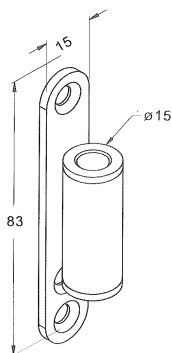

4002

BN

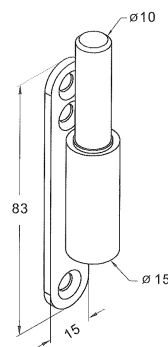

4003

BN

für Holzzargen

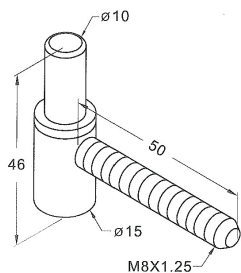

4004

BN

für Stahlzargen

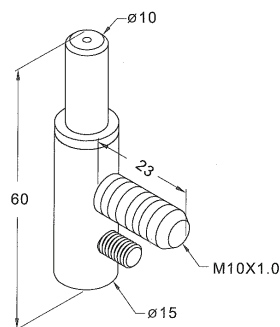

4005

BN

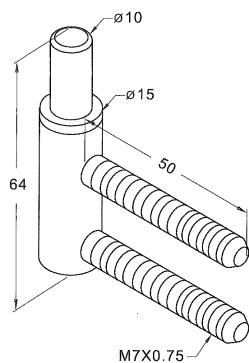

2



Selbstschließende Bänder/ Self-closing hinges

SC-1

BN



SC-2

BN

180° fluchtend



Maximale Kapazität Max. capacities	Türgewicht Door weight	Türbreite Door width
bei 2 Bändern Using 2 hinges	45 kg	900 mm

Glass Cut Outs

SC-1

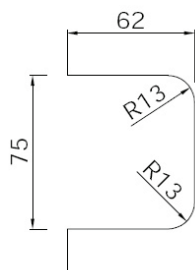

SC-2

